



Features

- 600 watts peak pulse power ($t_p = 8/20\mu s$)
- Response Time is Typically < 1 ns
- Small package for use in portable electronics
- Low capacitance
- Low leakage current
- Working Voltages: 5V

IEC Compatibility (EN61000-4)

- IEC 61000-4-2 (ESD) ± 30 kV (air), ± 30 kV (contact)
- IEC 61000-4-4 (EFT) 40A (5/50ns)
- IEC 61000-4-5 (Lightning) 20A (8/20 μs)

Mechanical Characteristics

- JEDEC SOT-23 package
- Molding compound flammability rating:
- UL 94V-0
- Marking : Marking Code
- Packaging : Tape and Reel per EIA 481
- RoHS Compliant

Circuit Diagram

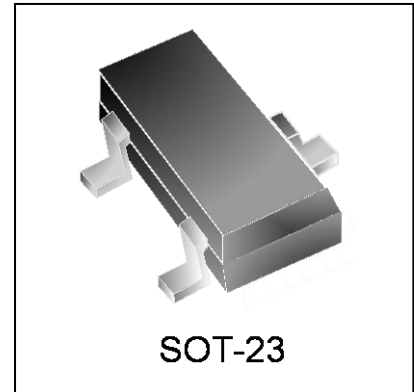
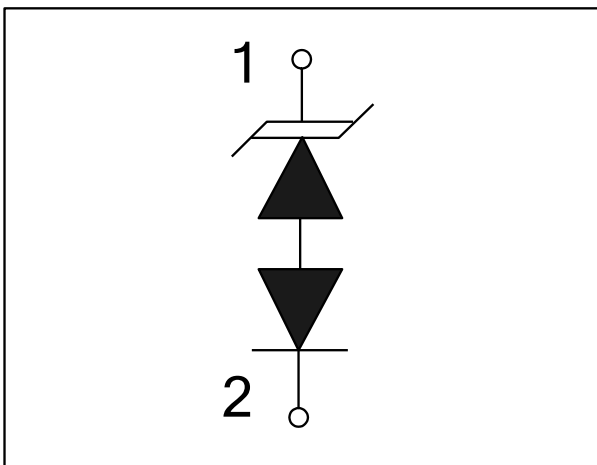

Applications

- High-speed data lines
- Cellular Handsets And Accessories
- Universal Serial Bus (USB) port protection
- Portable Electronics
- LAN/WAN equipment
- Desktop PC and Peripherals

Schematic & PIN Configuration

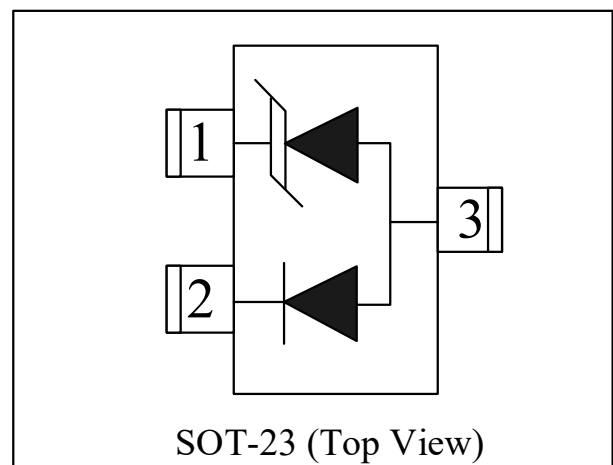

Absolute Maximum Rating			
Rating	Symbol	Value	Units
Peak Pulse Power ($t_p=8/20\mu s$)	P_{PP}	600	Watts
Lead Soldering Temperature	T_L	260(10sec)	$^{\circ}C$
Operating Temperature	T_J	-55 to + 125	$^{\circ}C$
Storage Temperature	T_{STG}	-55 to +150	$^{\circ}C$

Electrical Parameters (T=25 $^{\circ}C$)

Symbol	Parameter
I_{PP}	Maximum Reverse Peak Pulse Current
V_C	Clamping Voltage @ I_{PP}
V_{RWM}	Working Peak Reverse Voltage
I_R	Maximum Reverse Leakage Current @ V_{RWM}
V_{BR}	Breakdown Voltage @ I_T
I_T	Test Current
I_F	Forward Current
V_F	Forward Voltage @ I_F

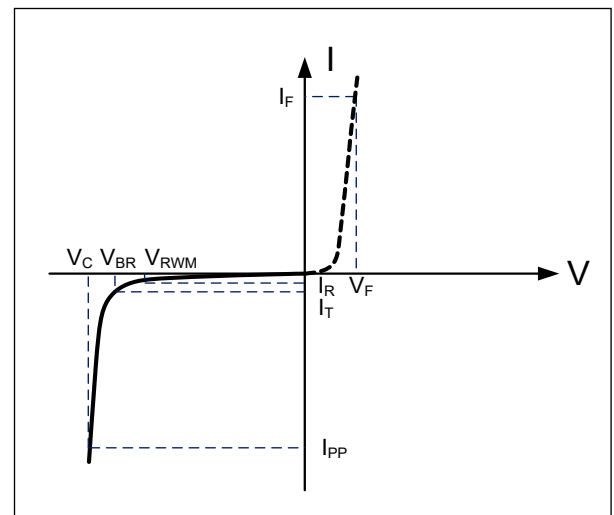

Electrical Characteristics

DW05LUC-S						
Parameter	Symbol	Conditions	Minimum	Typical	Maximum	Units
Reverse Stand-Off Voltage	V_{RWM}				5	V
Reverse Breakdown Voltage	V_{BR}	$I_T=1mA$	6			V
Reverse Leakage Current	I_R	$V_{RWM}=5V, T=25^{\circ}C$			1	μA
Peak Pulse Current	I_{PP}	$t_p=8/20\mu s$			20	A
Clamping Voltage	V_C	$I_{PP}=1A, t_p=8/20\mu s$			9.8	V
Maximum Clamping Voltage	V_C	$I_{PP}=20A, t_p=8/20\mu s$		26	28	V
Junction Capacitance	C_j	Pin 1 to 2 $V_R = 0V, f = 1MHz$		0.5	0.8	pF

Typical Characteristics

Figure 1: Peak Pulse Power Vs Pulse Time

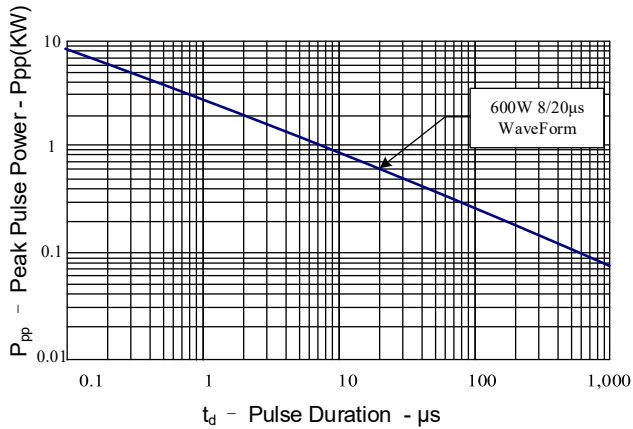

Figure 2: Power Derating Curve

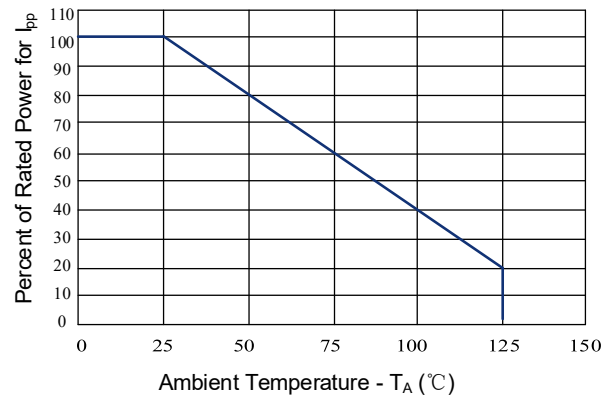

Figure 3: Clamping Voltage vs. Peak Pulse Current

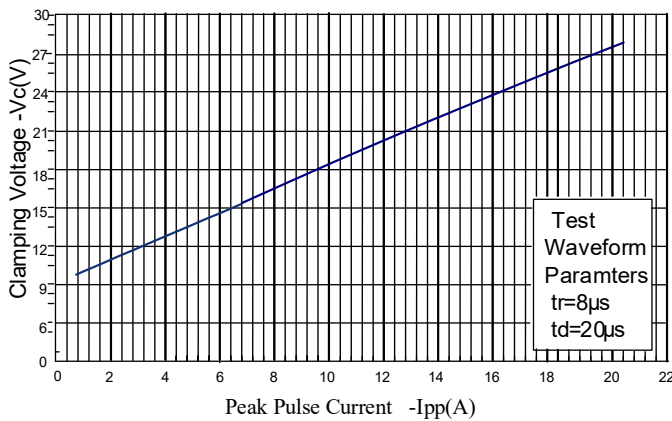

Figure 4: IEC 61000-4-2 Discharge Parameters

Level	First Peak Current (A)	Peak Current at 30 ns (A)	Peak Current at 60 ns (A)	Test Voltage (Contact Discharge) (kV)	Test Voltage (Air Discharge) (kV)
1	7.5	4	2	2	2
2	15	8	4	4	4
3	22.5	12	6	6	8
4	30	16	8	8	15

Figure 5: 8/20μs Pulse Waveform

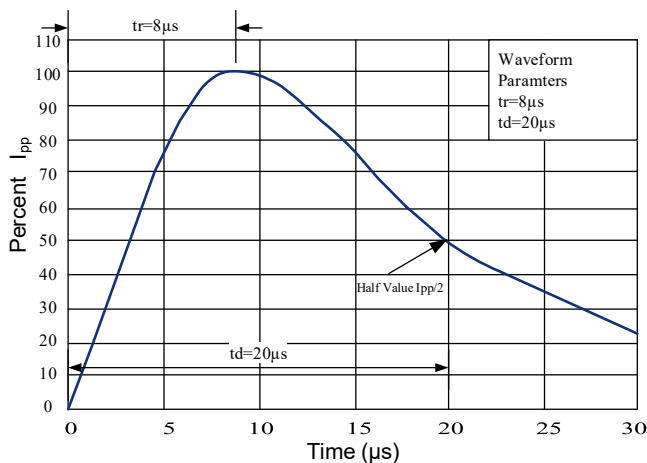
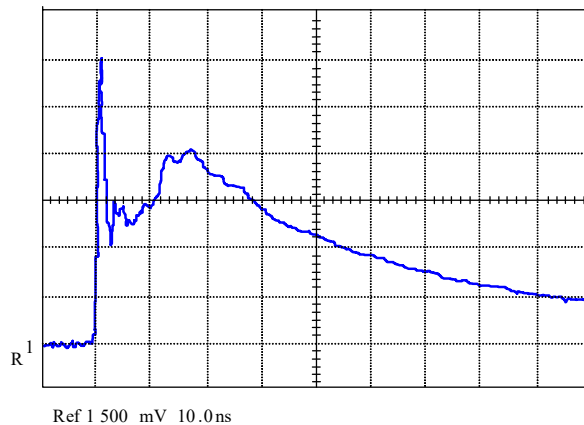
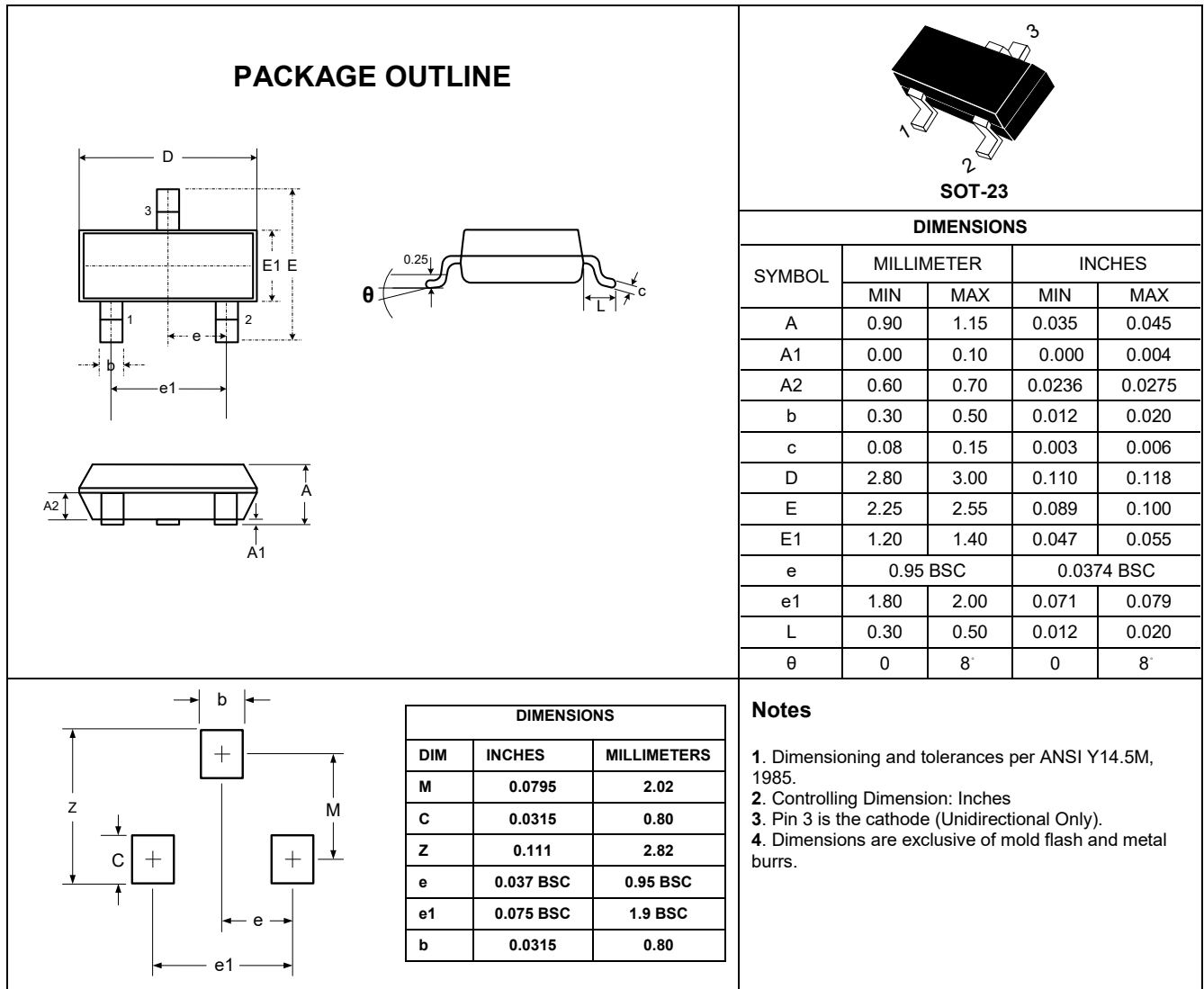

Figure 6: ESD Clamping(8kV Contact per IEC 61000-4-2)



Outline Drawing – SOT-23



Marking Codes

Part Number	DW05LUC-S
Marking Code	05L

Package Information

Qty: 3k/Reel